

**SPECIFICATION**

50Hz

Rev. I

<b>PUMP</b>		
Liquid Handled	Type of liquid	Clean / dirty water
	Max temperature [°C]	35
	Max solids size [mm]	10 (suspended particles)
Maximum immersion	[m]	7
Construction	Impeller	Open centrifugal type
	Shaft seal type	Double mechanical seal
	Bearing	Sealed ball bearing
Pipe Connection	Suction-Flange	Strainer
	Discharge-Flange [inch]	G 1½ UNI ISO 228
Material	Casing	AISI 304
	Impeller	AISI 304
	Casing cover	AISI 304
	Shaft seal	Pump side : SiC/SiC/NBR Motor side : Carbon/Ceramic/NBR
	Seal cover	AISI 304
	Shaft	AISI 303 (wet extension)
	Lubricating liquid	White mineral oil ESSO MARCOL 172 (180 cc)
Applicable standard of test	ISO 9906:2012 – Grade 3B	

<b>MOTOR</b>		
Type	Submersible dry type	
	Single Phase	Three Phase
No. of Poles	2	
Rotation speed [min <sup>-1</sup> ]	≈2800	
Insulation Class	F	
Protection degree	IP 68	
Power rating	[kW]	0.55 ÷ 1.1
	[HP]	0.75 ÷ 1.5
Frequency [Hz]	50	
Voltage [V]	230 ±10%	400 ±10%
Capacitor	Built in	-
Over load protection	Built in	-
Float Switch	Optional	-
Float Switch material	H07RN-F	-
Cable size	3G1	-
Casing material	AISI 304	
Base material/motor support	AISI 304	
Power cable	length [m]	10
	material	H07RN-F
	size	3G1 (Best 2) 3G1.5 (Best 3, 4)
Dimensions of cable entry	Cable Gland	

**SELECTION CHART**

50Hz

Rev. I

**PERFORMANCE RANGE**

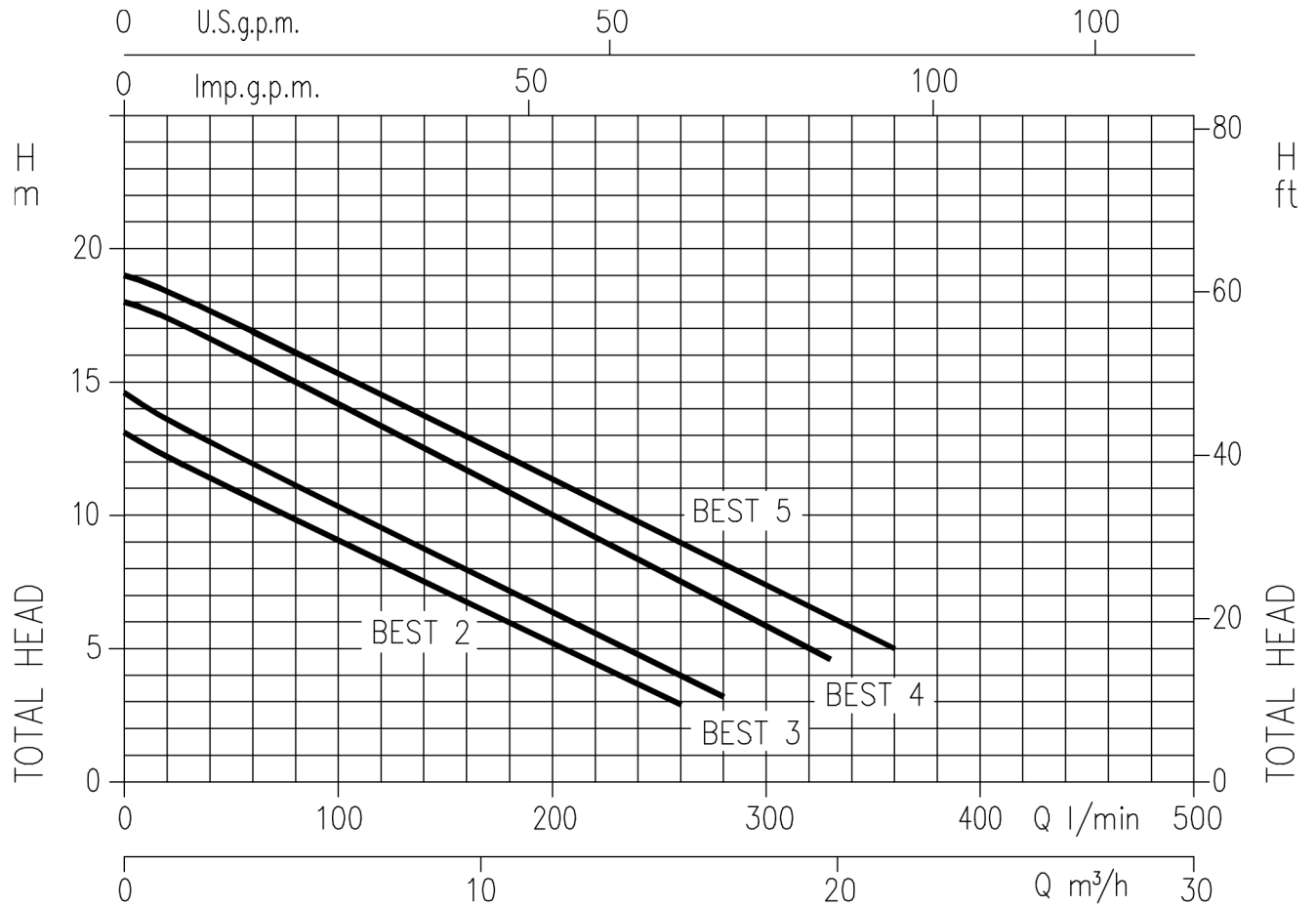

**SELECTION CHART**

Pump type	Power		Q=Capacity													
	[kW]	[HP]	l/min	0	20	40	80	120	160	170	200	260	280	300	330	360
			m³/h	0	1.2	2.4	4.8	7.2	9.6	10.2	12	15.6	16.8	18	19.8	21.6
			H=Total manometric head in meters													
BEST 2	0.55	0.75		13.1	12.2	11.4	9.8	8.3	6.7	6.3	5	2.9	-	-	-	-
BEST 3	0.75	1		14.6	13.6	12.7	11.1	9.5	7.9	7.6	6.4	4	3.2	-	-	-
BEST 4	1.1	1.5		18	17.4	16.6	15	13.4	11.7	11.3	10	7.5	6.7	5.9	4.6	-
BEST 5	1.5	2		19	18.4	17.7	16.1	14.5	12.8	12.5	11.4	9	8	7.4	6	5

**TYPE KEY**

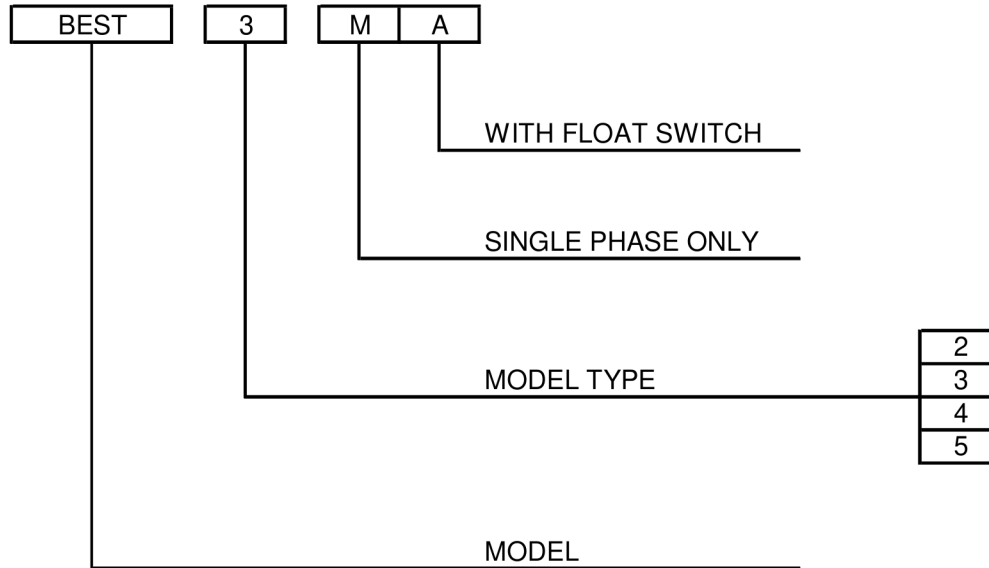

**PERFORMANCE CURVE SPECIFICATIONS**

The specifications below qualify the curves shown on the following pages.

Tolerances according to ISO 9906:2012 – Grade 3B

The curves refer to effective speed of asynchronous motors at 50 Hz, 2 poles.

Measurements were carried out with clean water at 20°C of temperature and with a kinematic viscosity of  $\nu = 1 \text{ mm}^2/\text{s}$  (1 cSt)

In order to avoid the risk of over-heating, the pumps should not be used at a flow rate below 10% of best efficiency point.

Symbols explanation:

- Q = volume flow rate
- H = total head

**BEST 5 (1.5 kW) – impeller diameter = 125 mm**

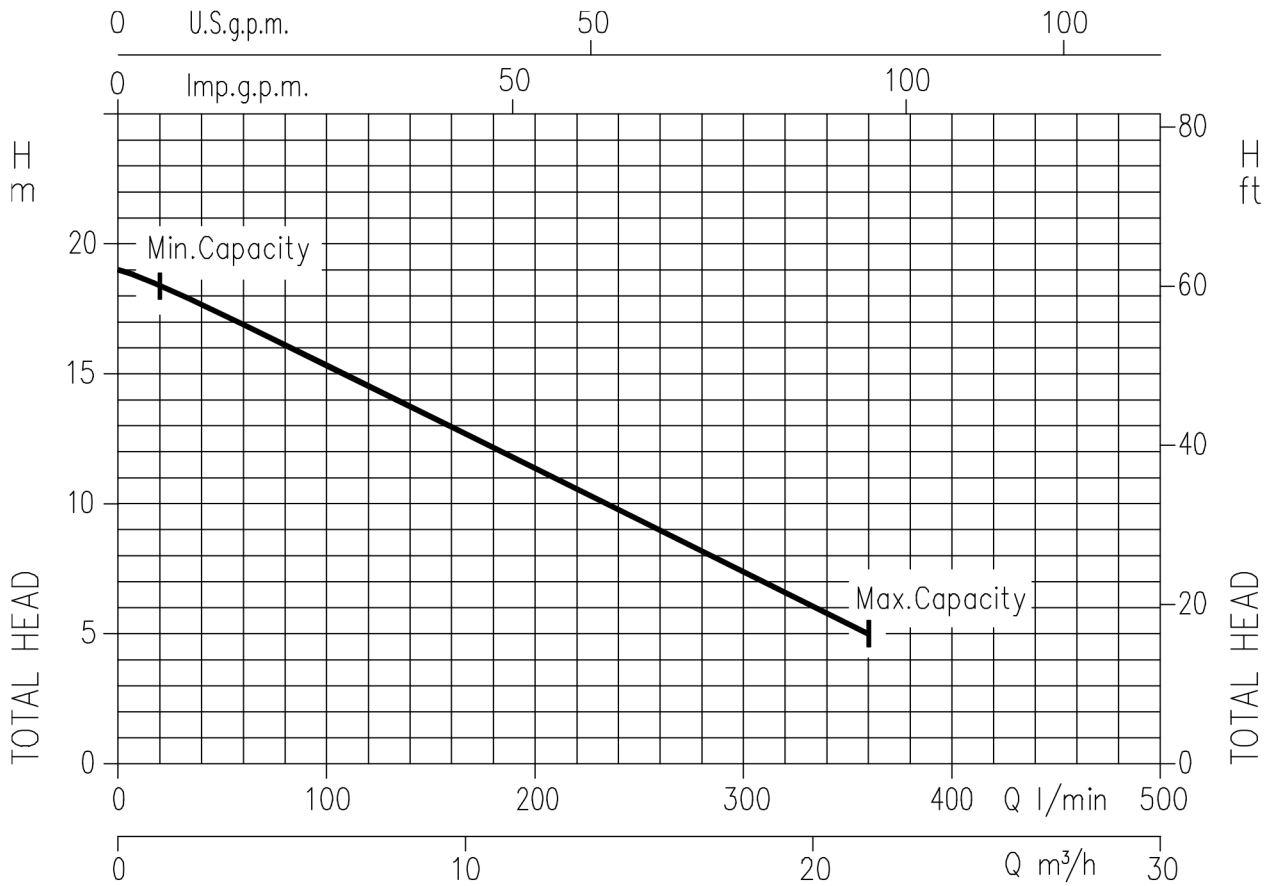

Rotation speed  $\approx 2800 \text{ min}^{-1}$   
Test standard: ISO 9906:2012 - Grade 3B

**SECTIONAL VIEW**

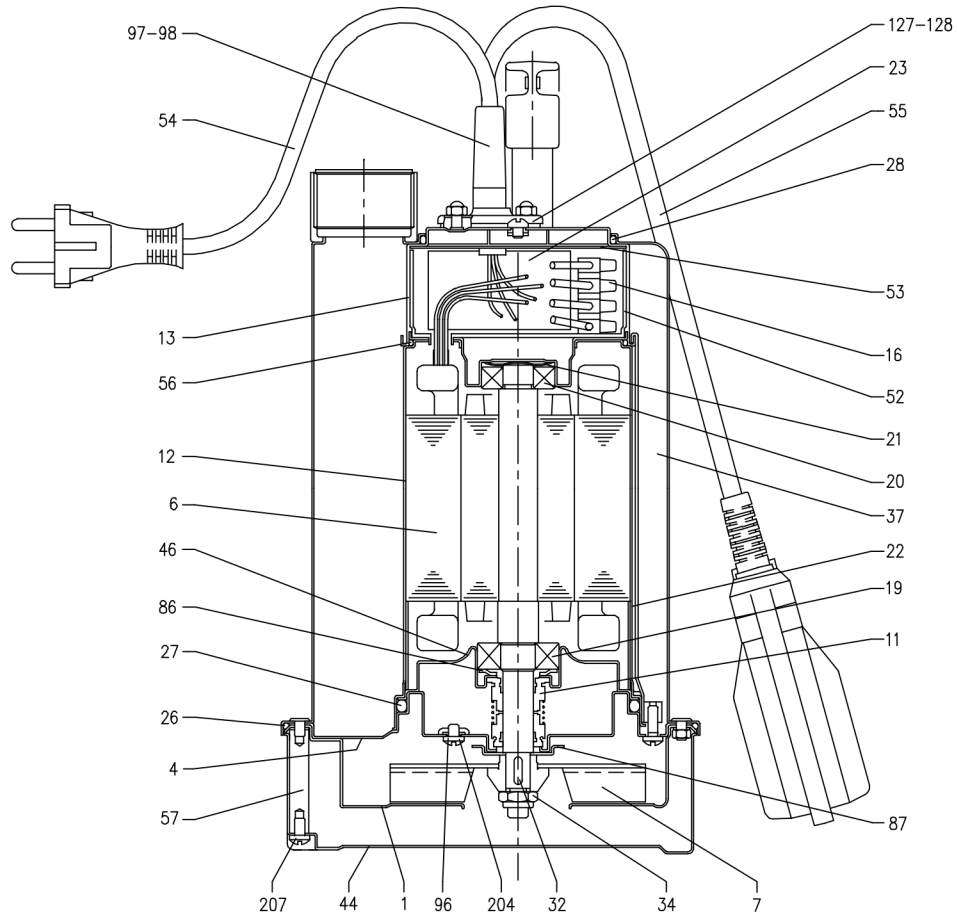

N°	PART NAME	MATERIAL	Q.TY
1	Volute	AISI 304	1
4	Motor bracket	AISI 304	1
6	Shaft with rotor	AISI 303	1
7	Impeller	AISI 304	1
11	Mechanical seal [4]	NBR	2
12	Motor frame with stator	-	1
13	Motor cover	AISI 304	1
16	Terminal	-	1
19	Pump side ball bearing	-	1
20	Fan side ball bearing	-	1
21	Adjusting ring	Steel C70	1
22	Tie rod	AISI 304	3
23	Capacitor [2]	-	1
26	"O" Ring	NBR	1
27	"O" Ring	NBR	1
28	"O" Ring	NBR	1
32	Key	AISI 304	1
34	Impeller nut	AISI 304	1

N°	PART NAME	MATERIAL	Q.TY
37	Pump casing	AISI 304	1
44	Strainer	AISI 304	1
46	Bearing housing	AISI 304	1
52	Terminal insulating box	PA66 glass fibre reinforced class V-0	1
53	Terminal insulating cover	PA66 class V-0	1
54	Power cable	-	1
55	Float switch [1]	-	1
56	"O" Ring	NBR	1
57	Bolt	AISI 303	3
86	Washer	AISI 304	1
87	Impeller ring	AISI 304	1
96	"O" Ring	NBR	3
97	Cable connector [1]	NBR	1
98	Cable connector	NBR	1
127	Cable connector [1]	AISI 304	1
128	Cable connector	AISI 304	1
204	Screw	Stainless steel A2 UNI 7323	3
207	Screw	Stainless steel A2 UNI 7323	3

[1] Only for version single phase with float switch  
 [2] Only for version single phase  
 [3] See Mechanical Seal dimensions at page 301

**BEARINGS**

Type pumps		Ball Bearing	
Single Phase	Three Phase	Pump side	Fan side
BEST 2M	BEST 2	6203 ZZ	6202 ZZ
BEST 3M	BEST 3	6203 ZZ	6202 ZZ
BEST 4M	BEST 4	6203 ZZ	6202 ZZ
-	BEST 5	6203 ZZ	6202 ZZ

**MECHANICAL SEAL**

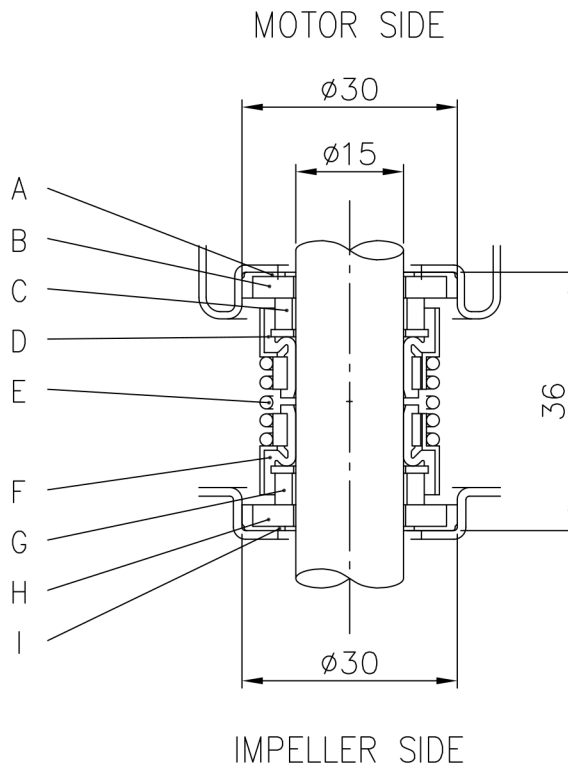

REF	PART NAME	MATERIAL
A	Rubber cup	NBR
B	Seat	Ceramic
C	Seal face	Carbon
D	Bellow	NBR
E	Spring	AISI 304
F	Bellow	NBR
G	Seal face	Silicon carbide
H	Seat	Silicon carbide
I	Rubber cup	NBR

**PUMP**

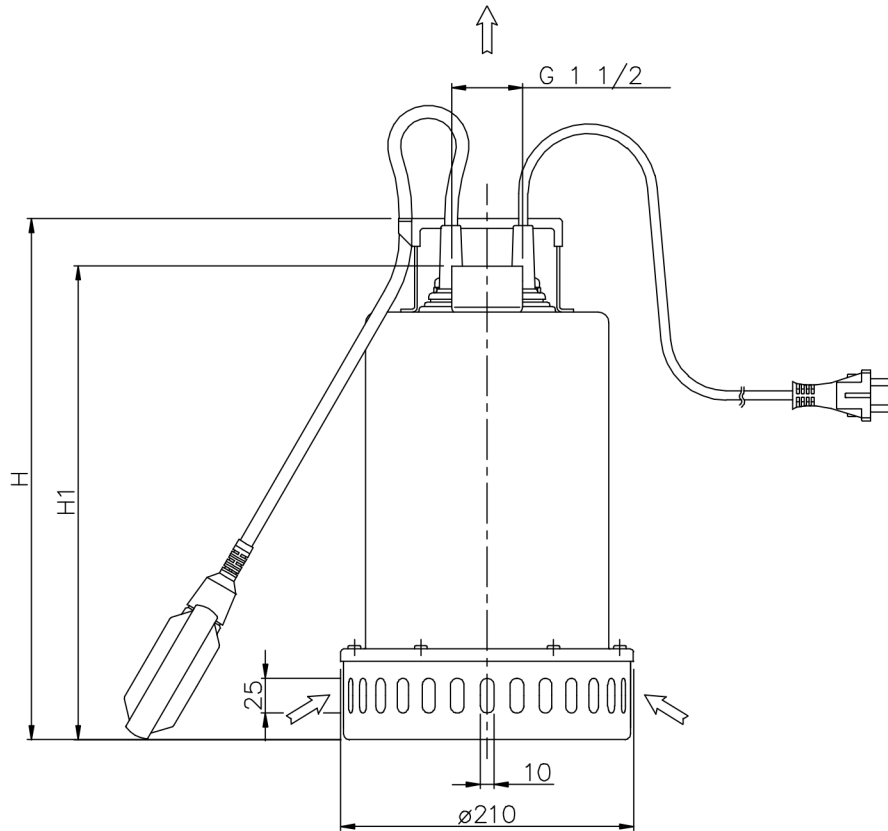

Pump type	Dimensions [mm]	
	H	H1
BEST 2	352	315
BEST 3	352	315
BEST 4	377	340
BEST 5	377	340

**MOTOR DATA**

Type pumps		Power		Capacitor Single Phase		Input [kW]		Full load current [A]		Locked rotor current [A]	
Single Phase	Three Phase	[kW]	[HP]	( F)	[Vc]	Single Phase	Three Phase	Single Phase	Three Phase	Single Phase	Three Phase
BEST 2M	BEST 2	0,55	0,75	16	450	0,9	1,0	4,4	2,0	16	10
BEST 3M	BEST 3	0,75	1	20	450	1,3	1,2	5,6	2,4	20	12,5
BEST 4M	BEST 4	1,1	1,5	30	450	1,7	1,6	7,3	3,0	25	16,5
-	BEST 5	1,5	2	-	-	-	1,7	-	3,3	-	16,5



INSTALLATION

