

# ULTRA SA



Pompe centrifughe multistadio orizzontali **autoadescanti**. Adatte alla movimentazione di liquidi non carichi; sistemi di pressurizzazione; irrigazione; acque potabili o con glicole in soluzione; trattamento acque; industria alimentare; riscaldamento e condizionamento; sistemi di lavaggio.

Stainless steel multistage horizontal **self-priming** pumps. Pumping of clean non-loaded fluids; pressurizing system; irrigation; drinking and glycol water; water treatment; heating and air conditioning; washing system.

Bombas centrífugas multietapas horizontales **autocebantes**. Bombeo de líquidos químicamente y mecánicamente no agresivos; sistemas de presurización; riegos; agua potable o con glicol; tratamientos del agua; industria alimenticia; calefacción y refrigeración; sistemas de lavado.

Pompes centrifuges multicellulaires horizontales **auto-amorçantes**. Pompage d'eaux propres non chargées; groupes de surpression; irrigation; eau potable ou solution de glycol; traitement des eaux; industrie alimentaire; chauffage et climatisation; stations de lavage auto.

## CARATTERISTICHE COSTRUTTIVE / CONSTRUCTION FEATURES CARACTERÍSTICAS CONSTRUCTIVAS / CARACTÉRISTIQUES D'EXÉCUTION

<b>Corpo pompa, disco portatenuta meccanica</b>	acciaio cromo-nichel AISI 304
<b>Pump body, mechanical seal housing</b>	stainless steel AISI 304
<b>Cuerpo bomba, apoyo sello mecánico</b>	acero cromo-níquel AISI 304
<b>Corps de pompe, plaque garniture mécanique</b>	acier chrome-nickel AISI 304

<b>Supporto motore</b>	alluminio
<b>Motor bracket</b>	aluminium
<b>Soporte motor</b>	aluminio
<b>Support moteur</b>	aluminium

<b>Giranti, diffusori</b>	acciaio cromo-nichel AISI 304
<b>Impellers, diffusers</b>	stainless steel AISI 304
<b>Rodetes, difusores</b>	acero cromo-níquel AISI 304
<b>Turbines, diffuseurs</b>	acier chrome-nickel AISI 304

<b>Tenuta meccanica</b>	ceramica-grafite
<b>Mechanical seal</b>	ceramic-graphite
<b>Sello mecánico</b>	cerámica-grafito
<b>Garniture mécanique</b>	céramique-graphite

<b>Albero motore</b>	acciaio cromo-nichel AISI 303
<b>Motor shaft</b>	stainless steel AISI 303
<b>Eje motor</b>	acero cromo-níquel AISI 303
<b>Arbre moteur</b>	acier chrome-nickel AISI 303

<b>Temperatura del liquido</b>	
<b>Liquid temperature</b>	-15 ÷ +110 °C
<b>Temperatura del líquido</b>	
<b>Température du liquide</b>	

<b>Pressione di esercizio</b>	
<b>Operating pressure</b>	max 7 bar
<b>Presión de trabajo</b>	
<b>Pression de fonctionnement</b>	

## MOTORE / MOTOR / MOTOR / MOTEUR

<b>Motore 2 poli a induzione</b>	3~ 230/400V-50Hz
----------------------------------	------------------

<b>2 pole induction motor</b>	1~ 230V-50Hz (con termoprotettore fino a 1,85kW with thermal protection up to 1,85 kW)
<b>Motor de 2 polos a inducción</b>	(con protección térmica hasta 1,85 kW avec protection thermique jusqu'à 1,85 kW)

<b>Moteur à induction à 2 pôles</b>	
-------------------------------------	--

<b>Classe di isolamento</b>	
<b>Insulation class</b>	F
<b>Clase de aislamiento</b>	
<b>Classe d'isolation</b>	

<b>Grado di protezione</b>	
<b>Protection degree</b>	IP44
<b>Grado de protección</b>	
<b>Protection</b>	

## U 3 S A - 100/5 T

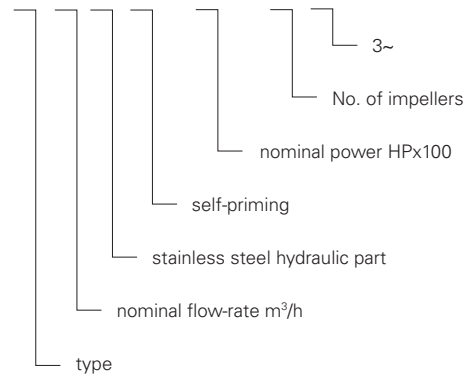

TYPE	TRUCK		CONTAINER	
	PALLET (cm)	N° pumps	PALLET (cm)	N° pumps
U 3SA-90/4	85x110x160	70	85x110x185	80
U 3SA-100/5	80x120x150	42	80x120x175	49
U 5SA-120/4	80x120x150	42	80x120x175	49
U 5SA-150/5	80x120x150	42	80x120x175	49

# ULTRA SA

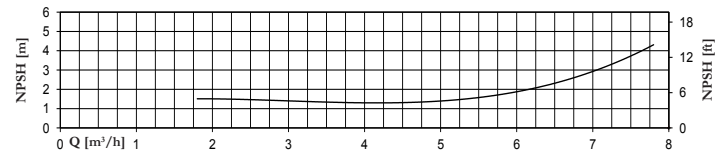
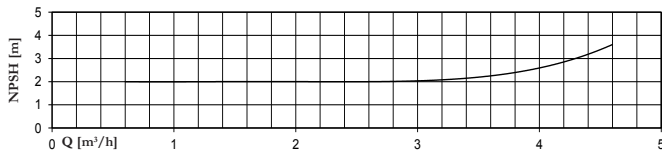
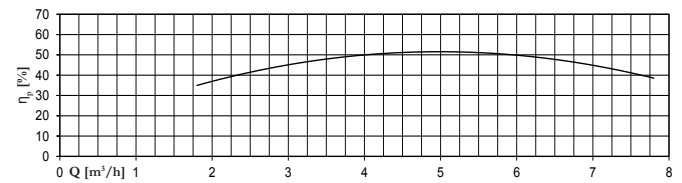
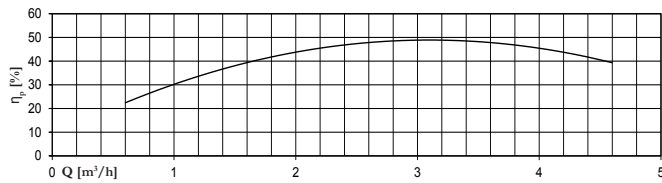
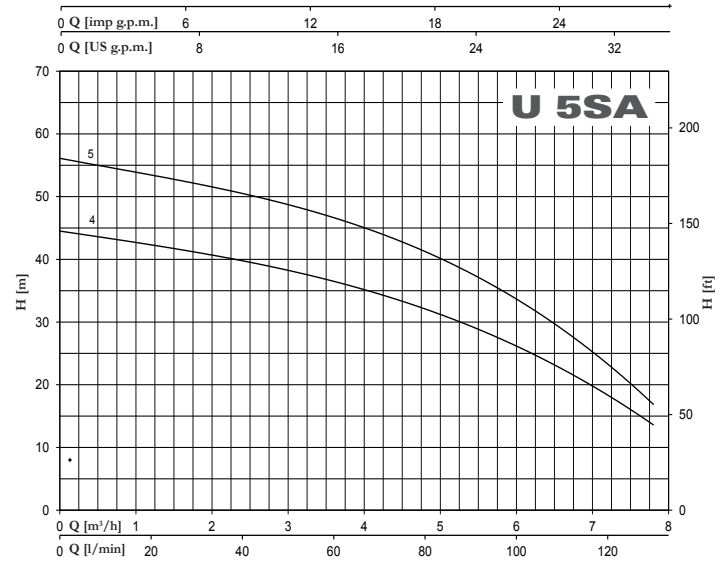
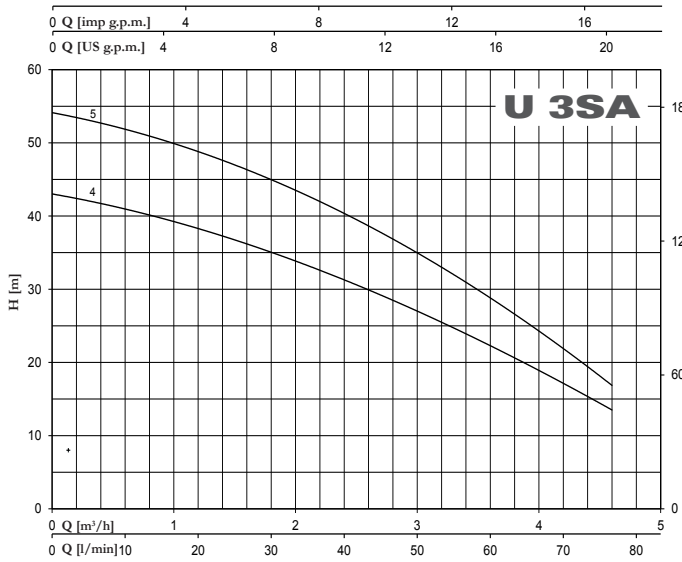

TYPE		P2		P1 (kW)		AMPERE		Q (m³/h - l/min)															
1~	3~	(HP)	(kW)	1~	3~	1~		H (m)															
						1x230 V 50 Hz	3x400 V 50 Hz	0	0,6	1,2	1,8	2,4	3,6	4,6	4,8	6	7,2	7,8					
U 3SA-90/4	U 3SA-90/4 T	0,9	0,66	0,83	0,8	3,6	1,7	43,0	41,0	38,3	35,0	31,3	22,3	13,5									
U 3SA-100/5	U 3SA-100/5 T	1	0,75	0,99	0,92	4,4	1,7	54,0	52,1	48,8	44,9	40,2	29,0	16,8									
U 5SA-120/4	U 5SA-120/4 T	1,2	0,9	1,09	1,08	4,9	2,4	44,5			41,0	40,0	36,4	32,8	32,0	26,2	18,5	13,5					
U 5SA-150/5	U 5SA-150/5 T	1,5	1,1	1,39	1,31	6,5	2,7	56,0			52,4	50,5	46,4	42,0	41,0	33,8	23,8	16,5					

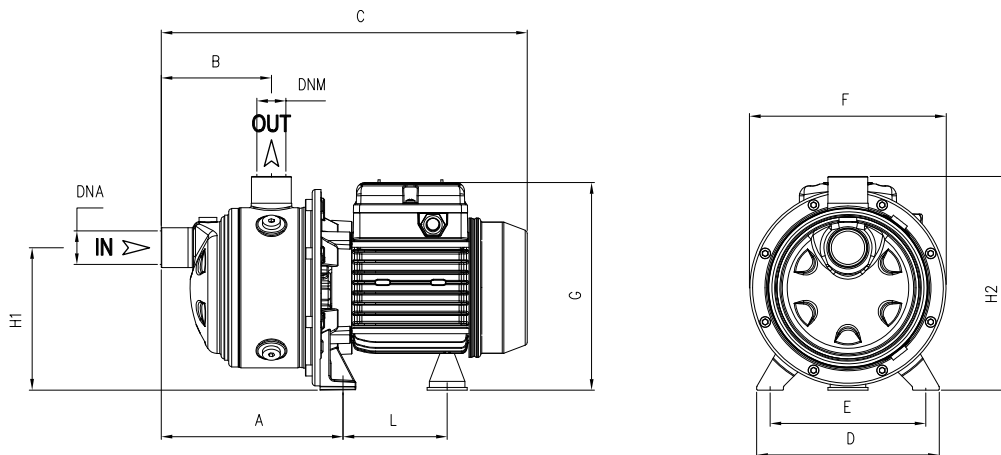

TYPE	DIMENSIONS (mm)										Kg	DNA	DNM
	A	B	C	D	E	F	G	L	H1	H2			
U 3SA-90/4	190,8	175	405	164	140	178	190	93,7	128	192	10	1" G	1" G
U 3SA-100/5	214,8	199	452	164	140	178	203	104,7	128	192	12,5		
U 5SA-120/4	190,8	175	428	164	140	178	203	104,7	128	192	12,5		
U 5SA-150/5	214,8	199	514	164	140	201	211	128,2	134	198	15,5		

