

# WAND MODULE FOR X2™ CONTROLLERS

*QUICK START GUIDE*

[hydrawise.com](http://hydrawise.com)  
[hunterindustries.com](http://hunterindustries.com)

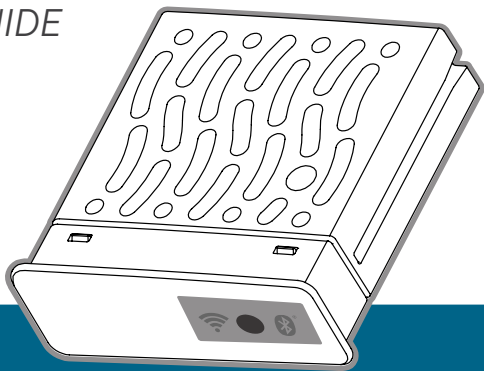

**Hunter®**

## Thank You for Purchasing a Hydrawise Compatible Device

---

The WAND Module allows your X2 Controller to connect to the internet via your Wi-Fi router. Once connected, you can access and manage the controller with your smartphone, tablet, or computer.

Need more helpful information about your product?



<https://hunter.help/wandhelp>  
[support@hydrawise.com](mailto:support@hydrawise.com)

### Step 1: Check the Wi-Fi signal

Use your smartphone to check the signal strength for the desired Wi-Fi connection at the controller location. If the strength is poor, the connection will not work. In this case, move the controller or router to improve the signal.



### Important:

Obstructions such as interior walls and landscaping can block the signal.

Need help? Run the Wi-Fi Wizard App.



<https://hunter.info/wifiwizardiOS>



<https://hunter.info/wifiwizardAndroid>



## **DE** Vielen Dank, dass Sie sich für ein mit Hydrawise kompatibles Gerät entschieden haben

Dank des WAND-Moduls kann Ihr X2-Steuergerät über Ihren WLAN-Router eine Verbindung zum Internet herstellen. Sobald dies geschehen ist, können Sie per Smartphone, Tablet oder Computer auf das Steuergerät zugreifen und es verwalten.

Wünschen Sie weitere hilfreiche Informationen zu Ihrem Produkt? Hier finden Sie Tipps zur Installation, Programmieranweisungen und weiteres.

Für Hilfe scannen?

<https://hunter.help/wandhelp>

### **Schritt 1: WLAN-Signal überprüfen**

Mit Ihrem Smartphone können Sie die Signalstärke für die gewünschte WLAN-Verbindung am Standort des Steuergeräts überprüfen. Ist das Signal zu schwach, kann keine Verbindung hergestellt werden. Wechseln Sie in diesem Fall den Standort des Steuergeräts oder des Routers, um ein besseres Signal zu empfangen.

Benötigen Sie Unterstützung? Führen Sie die Wi-Fi Assistenten aus.

<https://hunter.direct/wifiwizardiOS>  
<https://hunter.direct/wifiwizardAndroid>

**!** Wichtig: Hindernisse wie Innenwände und Landschaftselemente können das Signal blockieren.

## **ES** Gracias por comprar un dispositivo compatible con Hydrawise

El módulo WAND permite que el programador X2 se conecte a Internet a través de su router Wi-Fi. Una vez conectado, puede acceder y administrar el programador con su teléfono móvil, tableta u ordenador.

¿Necesita más información sobre el producto? Encuentre consejos de instalación, programación y más.

¿Necesita ayuda?

<https://hunter.help/wandhelp>

### **Paso 1: Compruebe la señal de Wi-Fi**

Use su teléfono móvil para comprobar la fuerza de la señal Wi-Fi deseada en la ubicación del programador. Si la señal es demasiado débil, no funcionará la conexión. En ese caso, mueva el programador o el router para mejorar la señal.

¿Necesita ayuda? Ejecute la aplicación Wi-Fi Wizard.

<https://hunter.direct/wifiwizardiOS>  
<https://hunter.direct/wifiwizardAndroid>

**!** Importante: Las obstrucciones como las paredes interiores y algunos elementos del paisaje pueden bloquear la señal.

# Thank You for Purchasing a Hydrawise Compatible Device

---

## **FR** Merci d'avoir acheté un appareil compatible Hydrawise

Le module WAND permet à votre programmeur X2 de se connecter à Internet via votre routeur Wi-Fi. Une fois connecté, vous pouvez accéder au programmeur et le gérer depuis votre smartphone, tablette ou ordinateur.

Vous avez besoin d'informations supplémentaires sur votre produit ? Découvrez des conseils sur l'installation, la configuration des programmeurs et bien plus encore.

Scannez le code QR pour obtenir de l'aide : <https://hunter.help/wandhelp>

### **Étape 1 : Vérification du signal Wi-Fi**

À l'aide de votre smartphone, vérifiez l'intensité du signal au niveau du programmeur pour la connexion Wi-Fi voulue. Si l'intensité est faible, la connexion ne s'établira pas. Dans ce cas, déplacez le programmeur ou le routeur pour améliorer le signal.

Vous avez besoin d'aide ? Lancez l'assistant Wi-Fi.

<https://hunter.direct/wifiwizardiOS>  
<https://hunter.direct/wifiwizardAndroid>

**!** Important : Les obstacles tels que les murs intérieurs et les aménagements paysagers peuvent bloquer le signal.

## **IT** Grazie per aver acquistato un dispositivo compatibile con Hydrawise

Il modulo WAND consente al programmatore X2 di collegarsi a internet tramite il vostro router Wi-Fi. Una volta stabilita la connessione, è possibile accedere e gestire il programmatore con uno smartphone, tablet o computer.

Hai bisogno di ulteriori informazioni sul tuo prodotto? Trova suggerimenti su installazione, impostazioni del programmatore e altro ancora.

Scansionare il codice QR per assistenza: <https://hunter.help/wandhelp>

### **Passaggio 1: controllare il segnale Wi-Fi**

Utilizzare lo smartphone per verificare la forza del segnale Wi-Fi scelto nella posizione del programmatore. Se il segnale è scarso, la connessione non funzionerà. Se così fosse, spostare il programmatore o il router per migliorare la forza del segnale.

Hai bisogno di aiuto? Esegui l'app di configurazione guidata Wi-Fi.  
<https://hunter.direct/wifiwizardiOS>  
<https://hunter.direct/wifiwizardAndroid>

**!** Importante: Gli ostacoli, come pareti interne o elementi del paesaggio, potrebbero bloccare il segnale.

## **PT** Obrigado por comprar um dispositivo compatível com o Hydrawise

O módulo WAND permite que o controlador X2 conecte-se à internet pelo roteador Wi-Fi. Uma vez conectado, pode-se acessar e gerenciar o controlador pelo smartphone, tablet ou computador.

Deseja mais informações sobre seu produto? Confira dicas de instalação, programação de controladores e muito mais.

Procurar ajuda?

<https://hunter.help/wandhelp>

### **Etapa 1: verifique o sinal do Wi-Fi**

Use o seu smartphone para verificar a intensidade do sinal da conexão Wi-Fi desejada no local do controlador. Se o sinal estiver muito fraco, a conexão não funcionará. Nesse caso, mude o controlador ou o roteador de lugar para melhorar o sinal.

Precisa de ajuda? Utilize o aplicativo assistente para Wi-Fi.

<https://hunter.direct/wifiwizardiOS>  
<https://hunter.direct/wifiwizardAndroid>

**!** Importante: Obstáculos como paredes internas e paisagismo podem bloquear o sinal.

## **TR** Hydrawise Uyumlu bir Cihaz satın aldığınız için teşekkür ederiz

WAND modülü, X2 kontrol ünitenizin Wi-Fi yönlendiriciniz (router) üzerinden internete bağlanmasını sağlar. Bağlandıktan sonra akıllı telefonunuzla, tabletinizle veya bilgisayarınızla kontrol ünitesine erişebilir ve kontrol ünitenizi yönetebilirsiniz.

Ürününüz hakkında daha çok faydalı bilgiye ulaşmak ister misiniz? Kontrol ünitesi programlama, kurulum ve daha fazlası hakkında ipuçları edinin.

Yardım için taransın mı?

<https://hunter.help/wandhelp>

### **1. Adım: Wi-Fi Sinyalini kontrol edin**

Kontrol ünitesi konumunda istediğiniz Wi-Fi bağlantısının sinyal gücünü kontrol etmek için akıllı telefonunuzu kullanın. Güç zayıfsa bağlantı çalışmaz. Bu durumda sinyali iyileştirmek için kontrol ünitesini veya yönlendiriciyi (router) hareket ettirin.

Yardıma ihtiyacınız var mı? Wi-Fi Sihirbazı uygulamasını çalıştırın.

<https://hunter.direct/wifiwizardiOS>  
<https://hunter.direct/wifiwizardAndroid>

**!** Önemli: İç duvarlarlar ve peyzaj düzenlemesi gibi engeller sinyali kesebilir.

## Product Installation

---

### Step 2: Installing the WAND Module

1. Remove the Wi-Fi cover from the X2 Controller.

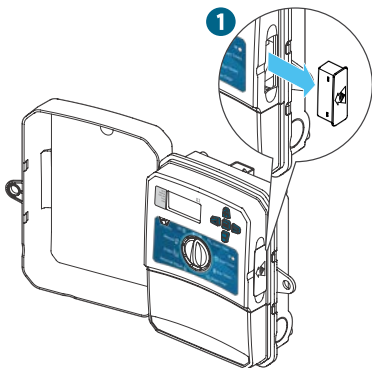

When installed, the WAND Module disables the X2 Controller's dial and button functions, the existing schedule, and settings.

Manual operation functions such as Start/ Stop Station and Test All Stations can still be activated from the controller.

2. Insert the WAND Module.

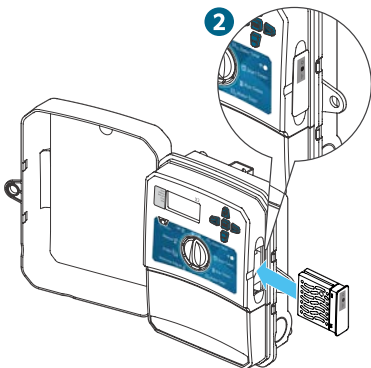

All programming is now managed via cloud-based Hydrawise Software from a smartphone, tablet, or desktop browser.

### **DE** Installation des Produkts **Schritt 2: WAND-Modul installieren**

1. Nehmen Sie die WLAN-Abdeckung vom X2-Steuergerät ab.

Nach der Installation deaktiviert das WAND-Modul die Schalter- und Tastenfunktionen am Steuergerät sowie den programmierten Berechnungsplan und die Einstellungen.

Manuelle Betriebsfunktionen wie „Station starten/stoppen“ und „Alle Stationen testen“ können weiterhin über das Steuergerät aktiviert werden.

2. Setzen Sie das WAND-Modul ein.

Die gesamte Programmierung verläuft nun über die cloudbasierte Hydrowise-Software per Smartphone, Tablet oder Desktop-Browser.

### **ES** Instalación del producto **Paso 2: Instalación del módulo WAND**

1. Quite la cubierta de la Wi-Fi del programador X2.

Cuando está instalado, el WAND deshabilita las funciones de dial y botones del programador, así como el programa y los ajustes actuales.

Las operaciones manuales como Encendido/Apagado de Estación y Probar Todas las Estaciones se pueden activar desde el programador.

2. Inserte el módulo WAND.

Toda la programación se maneja a través del software Hydrowise basado en la nube desde el navegador de un teléfono móvil, una tableta o un ordenador.

### **FR** Installation du produit **Étape 2 : Installation du module WAND**

1. Retirez le couvercle Wi-Fi du programmeur X2.

Une fois installé, le module désactive les fonctions du sélecteur et des boutons du programmeur, le calendrier actuel ainsi que les paramètres.

Les fonctions de commande manuelles telles que le démarrage/l'arrêt des stations et le test de toutes les stations peuvent tout de même être activées à partir du programmeur.

2. Insérez le module WAND.

Toute la programmation est alors gérée par le biais du logiciel cloud Hydrowise™, depuis un smartphone, une tablette ou un ordinateur.

### **IT** **Installazione del prodotto** **Passaggio 2: installare il modulo WAND**

1. Rimuovere il coperchio del Wi-Fi dal programmatore X2.

Quando viene installato, WAND disabilita le funzioni del selettore e dei pulsanti del programmatore, nonché le impostazioni e programmazioni esistenti.

Le funzioni manuali, come Avvia/ Interrompi stazione e Test di tutte le stazioni possono lo stesso essere attivate dal programmatore.

2. Inserire il modulo WAND.

Tutta la programmazione verrà quindi gestita tramite il software basato su cloud Hydrawise dal browser di uno smartphone o di un computer.

### **PT** **Instalação do produto** **Etapa 2: instalação do módulo WAND**

1. Remova a tampa do Wi-Fi do controlador X2.

Quando instalado, o WAND desativa as funções do seletor e dos botões do controlador, a programação e as configurações existentes.

As funções de operação manual, como Iniciar/Parar Seção e Testar Todas as

Seções, podem ainda ser ativadas no controlador.

2. Insira o módulo WAND.

Toda a programação será então gerenciada pelo software Hydrawise na nuvem por meio de um smartphone, tablet ou navegador para desktop.

### **TR** **Ürün Kurulumu** **2. Adım: WAND Modülünün Montajı**

1. Wi-Fi kapağını X2 kontrol ünitesinden çıkarın.

WAND modülü takıldığında, kontrol ünitesinin kadran ve tuş işlevlerini, mevcut programları ve ayarları devre dışı bırakır.

İstasyonu Başlatma/Durdurma ve Tüm İstasyonları Test Etme gibi manuel çalışma fonksiyonları halen kontrol cihazından çalıştırılabilir.

2. WAND modülünü takın.

Artık programlamanın tamamı, akıllı telefon, tablet veya masaüstü tarayıcısından Hydrawise bulut tabanlı yazılımı aracılığıyla yönetiliyor.



### Step 3: Navigating WAND with X2

Locate the following:

- A. Wi-Fi status LED
- B. Wi-Fi setup button
- C. WAND serial number

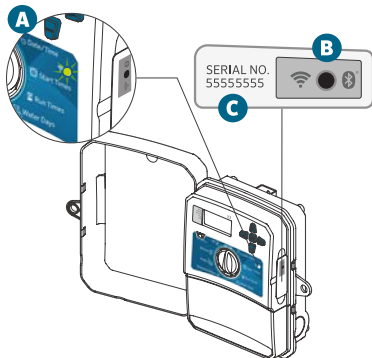

The serial number is used to enable Hydrawise management for the WAND Module. You will be prompted to enter the serial number during the online setup process when adding the controller to your Hydrawise account.

Leave the WAND Module installed with the dial in the RUN position during setup to remain connected to Hydrawise Software. If the WAND Module is removed, the controller will revert to the programs and settings configured via the dial and buttons.

To ensure the X2 Controller operates with Hydrawise, you must have the dial in the Run position. The controller will not operate remotely if the dial is in any other position.

### DE Produktübersicht Schritt 3: WAND mit X2 steuern

Machen Sie Folgendes ausfindig:

- A. Wi-Fi-Status LED
- B. Wi-Fi-Setup Taste
- C. WAND Seriennummer

Das Hydrawise-Management für das WAND-Modul wird über die Seriennummer aktiviert. Sie werden während des Online-Einrichtungsvorgangs zur Eingabe der Seriennummer aufgefordert, wenn Sie das Steuergerät zu Ihrem Hydrawise-Konto hinzufügen möchten.

Lassen Sie während der Einrichtung das WAND-Modul installiert und stellen Sie den Drehschalter auf die Position RUN (BETRIEB), damit die Verbindung zur

Hydrawise-Software bestehen bleibt. Wenn das WAND-Modul entfernt wird, wird das Steuergerät auf die über den Drehschalter und die Tasten konfigurierten Programme und Einstellungen zurückgesetzt.

Zur Gewährleistung des Betriebs des X2-Steuergeräts mit Hydrawise muss sich der Drehschalter auf der Position Run (Betrieb) befinden. Das Steuergerät kann nicht aus der Ferne bedient werden, wenn sich der Drehschalter auf einer anderen Position befindet.

### **ES** Resumen del producto **Paso 3: Manejo de WAND con X2**

Localice lo siguiente:

- A. LED de estatus de Wi-Fi
- B. Botón de configuración Wi-Fi
- C. Número de serie del WAND

El número de serie se utiliza para habilitar la gestión del módulo WAND por Hydrawise. Se le pedirá que introduzca el número de serie durante el proceso de configuración en línea al añadir el programador a su cuenta de Hydrawise.

Deje el módulo WAND instalado con el dial en la posición RUN durante la configuración para permanecer conectado al software

Hydrawise. Si se quita el WAND, el programador volverá a los programas y a la configuración introducidos mediante el dial y los botones.

Para asegurarse de que el programador X2 funcione con Hydrawise, debe tener el dial en la posición Run. El programador no funcionará a distancia si el dial se encuentra en otra posición.

### **FR** Présentation des produits **Étape 3 : Association WAND et X2**

Repérez les éléments suivants :

- A. Diode d'état Wi-Fi
- B. Bouton de paramétrage Wi-Fi
- C. Numéro de série du WAND

Le numéro de série permet d'activer la gestion Hydrawise du module WAND. Vous serez invité(e) à saisir le numéro de série pendant la configuration en ligne, au moment d'ajouter le programmeur à votre compte Hydrawise.

Lors de la configuration, laissez le sélecteur en position RUN et le module WAND installé afin de rester connecté au logiciel Hydrawise. En cas de retrait du module, le programmeur reviendra aux programmes et paramètres configurés à l'aide du sélecteur et des boutons.

Pour vérifier que le programmeur X2 fonctionne avec Hydrowise, le sélecteur doit être en position Run. Le programmeur ne fonctionnera pas à distance si le sélecteur se trouve sur une autre position.

### **IT** **Panoramica del prodotto** **Passaggio 3: utilizzare WAND con X2**

Individuare quanto segue:

- A. LED di stato Wi-Fi
- B. Pulsante di configurazione Wi-Fi
- C. Numero di serie WAND

Il numero di serie viene utilizzato per attivare la gestione di Hydrowise per il WAND e andrà inserito durante il processo di configurazione online, quando si aggiunge il programmeur all'account Hydrowise.

Durante la configurazione, lasciare installato il modulo WAND con il selettore nella posizione Acceso per mantenere la connessione al software Hydrowise. Se il WAND viene rimosso, il programmeur tornerà ai programmi e alle impostazioni configurati tramite selettore e pulsanti.

Per garantire che il programmeur X2 funzioni con Hydrowise, è necessario che il selettore si trovi nella posizione Acceso. Se il quadrante si trova in qualsiasi altra posizione, il programmeur non funzionerà da remoto.

### **PT** **Visão geral do produto** **Etapa 3: navegação do WAND com o X2**

Localize o seguinte:

- A. LED de status do Wi-Fi
- B. Botão de configuração do Wi-Fi
- C. Número de série do WAND

Use-se o número de série para ativar a gestão do Hydrowise para o WAND. Será necessário informar o número de série durante o processo de configuração online, quando for adicionar o controlador à sua conta do Hydrowise.

Deixe o módulo WAND instalado com o seletor na posição EXECUTAR durante a configuração, para permanecer conectado ao software do Hydrowise. Se o WAND for removido, o controlador fará a reversão para os programas e ajustes configurados por meio do seletor e dos botões.

Para garantir a operação do controlador X2 com o Hydrowise, é necessário colocar o seletor na posição Executar. O controlador não operará de forma remota se o seletor estiver em qualquer outra posição.



### Ürüne Genel Bakış

#### 3. Adım: X2 ile WAND'da gezinme

Aşağıdakileri bulun:

- A. Wi-Fi durumu LED ışığı
- B. Wi-Fi kurulum düğmesi
- C. WAND seri numarası

Seri numarası, WAND için Hydrawise yönetimini etkinleştirmek amacıyla kullanılır. Kontrol ünitesini Hydrawise hesabınıza eklerken çevrimiçi kurulum işlemi sırasında seri numarasını girmeniz istenir.

WAND modülünü, Hydrawise yazılımına bağlı kalmak için kurulum sırasında kadranla birlikte BAŞLAT konumunda bırakın. WAND kaldırılırsa, kontrol ünitesi kadran ve düğmelerle, yapılandırılan programlara ve ayarlara geri döner.

X2 kontrol ünitesinin Hydrawise ile çalışmasını sağlamak için kadranın Başlat konumunda olması gerekir. Kadran başka bir konumdaysa kumanda uzaktan çalışmaz.

### Step 4: Access Hydrawise Software



Download the Hydrawise App from the Apple® App Store or Google Play™ Store, or log on to [hydrawise.com](https://hunter.info/hydrawise.com).



<https://hunter.info/hydrawiseiOS>



<https://hunter.info/hydrawiseAndroid>



### Step 5: Adding your controller

#### New Hydrawise account user:

1. Register for a new account in your app or at [hydrawise.com](https://hydrawise.com).
2. After you have registered, click the “Let’s Get Started” button in the email sent to your account.
3. Click the “Let’s Get Started” button again on your Hydrawise app or website screen.
4. Continue following all steps to add your X2 Controller to your Hydrawise account and connect to Wi-Fi.

#### Existing Hydrawise account user:

1. Sign in to your Hydrawise app or account.
2. Navigate to “My Controllers” in the My Account ≡ drop-down menu.
3. Click the + icon under My Controllers list.
4. Continue following all steps to add your X2 Controller to your Hydrawise account and connect to Wi-Fi.

*Apple and the Apple logo are trademarks of Apple Inc., registered in the U.S. and other countries. App Store is a service mark of Apple Inc. Google Play is a trademark of Google LLC.*

### **DE** Einrichtung von Hydrawise **Schritt 4: Auf die Hydrawise-Software zugreifen**



Laden Sie die Hydrawise-App aus dem Apple® App Store oder Google Play™ Store herunter oder melden Sie sich auf [hydrawise.com](https://hunter.info/hydrawise.com) an.

<https://hunter.info/hydrawiseiOS>  
<https://hunter.info/hydrawiseAndroid>

### **Schritt 5: Steuergerät hinzufügen**

Für neue Hydrawise-Konto-Nutzer:

1. Registrieren Sie sich in Ihrer App oder auf [hydrawise.com](https://hunter.info/hydrawise.com) für ein neues Konto.
2. Klicken Sie nach der Registrierung auf die Schaltfläche „Los geht's!“ in der an Ihr Konto gesendeten E-Mail.
3. Klicken Sie in der Hydrawise-App oder auf der Website erneut auf die Schaltfläche „Los geht's!“.
4. Folgen Sie allen weiteren Schritten, um Ihr X2-Steuergerät zu Ihrem Hydrawise-Konto hinzuzufügen und eine WLAN-Verbindung herzustellen.

### **Für bestehende Hydrawise-Konto-Nutzer:**

1. Loggen Sie sich in Ihr Hydrawise-Konto ein.

2. Gehen Sie im Dropdown-Menü „Mein Konto“ auf „Meine Steuergeräte“.
3. Klicken Sie in der Liste „Meine Steuergeräte“ auf das Pluszeichen.
4. Folgen Sie allen weiteren Schritten, um Ihr X2-Steuergerät zu Ihrem Hydrawise-Konto hinzuzufügen und eine WLAN-Verbindung herzustellen.

### **ES** Configuración de Hydrawise **Paso 4: Acceda al software Hydrawise**



Descargue la aplicación Hydrawise de la App Store de Apple® o de la Google Play™ Store o inicie sesión en [hydrawise.com](https://hunter.info/hydrawise.com).

<https://hunter.info/hydrawiseiOS>  
<https://hunter.info/hydrawiseAndroid>

### **Paso 5: Añadir su programador**

Nueva cuenta de usuario de Hydrawise:

1. Regístrese para obtener una nueva cuenta en su aplicación o en [hydrawise.com](https://hunter.info/hydrawise.com).
2. Después de registrarse, haga clic en el botón "Empezar" en el correo electrónico enviado a su cuenta.

3. Vuelva a hacer clic en el botón "Empezar" en la aplicación o en la pantalla del sitio web Hydrawise.
4. Siga todos los pasos para añadir el programador X2 a su cuenta de Hydrawise y conectarse a la Wi-Fi.

### Cuenta de usuario existente de Hydrawise:

1. Inicie sesión en la aplicación o en su cuenta de Hydrawise.
2. Vaya a "Mis programadores" en el menú desplegable de Mi cuenta.
3. Haga clic en el icono + en la lista Mis programadores.
4. Siga todos los pasos para añadir el controlador X2 a su cuenta de Hydrawise y conectarse a la Wi-Fi.

### **FR** Configuration d'Hydrawise Étape 4 : Accès au logiciel Hydrawise



Téléchargez l'application Hydrawise à partir de l'App Store d'Apple® ou de la boutique Google Play™, ou connectez-vous sur [hydrawise.com](https://hunter.info/hdrawise.com).

<https://hunter.info/hdrawiseiOS>  
<https://hunter.info/hdrawiseAndroid>

### Étape 5 : Ajout de votre programmeur

Vous êtes un nouvel utilisateur d'Hydrawise :

1. Créez un nouveau compte sur l'application ou sur [hydrawise.com](https://hydrawise.com).
2. Une fois inscrit(e), cliquez sur le bouton « C'est parti » dans l'e-mail envoyé à l'adresse associée à votre compte.
3. Cliquez à nouveau sur le bouton « C'est parti » sur l'écran de votre application Hydrawise ou du site Web.
4. Suivez toutes les étapes pour ajouter votre programmeur X2 à votre compte Hydrawise et vous connecter au Wi-Fi.

### Vous êtes déjà utilisateur d'Hydrawise :

1. Connectez-vous à l'application ou à votre compte Hydrawise.
2. Accédez à « Mes programmeurs » dans le menu déroulant « Mon compte ».
3. Cliquez sur l'icône + sous la liste « Mes programmeurs ».
4. Suivez toutes les étapes pour ajouter votre programmeur X2 à votre compte Hydrawise et vous connecter au Wi-Fi.

### **IT** Configurazione Hydrawise

#### **Passaggio 4: accedere al software Hydrawise**



Scaricare l'app Hydrawise dall'App Store di Apple® o da Google Play™ Store, oppure accedere a [hydrawise.com](http://hydrawise.com).

<https://hunter.info/hydrawiseiOS>  
<https://hunter.info/hydrawiseAndroid>

#### **Passaggio 5: aggiungere il programmatore**

Nuovo account Hydrawise:

1. Registrare un nuovo account nell'app o su [hydrawise.com](http://hydrawise.com).
2. Dopo la registrazione, fare clic sul pulsante “Iniziamo” nell'e-mail inviata all'account.
3. Fare nuovamente clic sul pulsante “Iniziamo” nella schermata dell'app Hydrawise o del sito web.
4. Seguire tutti i passaggi per aggiungere il programmatore X2 all'account Hydrawise e connettersi al Wi-Fi.

#### **Account Hydrawise esistente:**

1. Eseguire l'accesso all'app o all'account Hydrawise.

2. Andare su “I miei programmatori” nel menu a tendina Il mio account.
3. Fare clic sull'icona “+” sotto l'elenco I miei programmatori.
4. Seguire tutti i passaggi per aggiungere il programmatore X2 all'account Hydrawise e connettersi al Wi-Fi.

### **PT** Configuração do Hydrawise

#### **Etapa 4: acesse o software Hydrawise**



Baixe o aplicativo Hydrawise na Apple® App Store ou na Google Play™ Store ou conecte-se em [hydrawise.com](http://hydrawise.com).

<https://hunter.info/hydrawiseiOS>  
<https://hunter.info/hydrawiseAndroid>

#### **Etapa 5: inclusão do controlador**

Novo usuário da conta do Hydrawise:

1. Inscreva-se para criar uma nova conta no seu aplicativo ou em [hydrawise.com](http://hydrawise.com).
2. Quando tiver feito a inscrição, clique no botão “Vamos começar” no e-mail enviado para sua conta.
3. Clique no botão “Vamos começar” novamente na tela do aplicativo ou no site do Hydrawise.



4. Siga todas as etapas para adicionar o controlador X2 à sua conta do Hydrawise e conectar-se ao Wi-Fi.

### Usuário existente da conta do Hydrawise:

1. Conecte-se à sua conta ou ao aplicativo Hydrawise.
2. Acesse “Meus controladores” no menu suspenso Minha conta.
3. Clique no ícone + na lista Meus controladores.
4. Siga todas as etapas para adicionar o controlador X2 à sua conta do Hydrawise e conectar-se ao Wi-Fi.



### Hydrawise Kurulumu

#### 4. Adım: Hydrawise Yazılımına

#### Erişim



Hydrawise uygulamasını Apple® App Store veya Google Play™ Store'dan indirin veya [hydrawise.com](https://hunter.info/hydrawise.com) adresinde oturum açın.

<https://hunter.info/hydrawiseiOS>

<https://hunter.info/hydrawiseAndroid>

#### 5. Adım: Kontrol Ünitenizi Ekleme

Yeni Hydrawise hesabı kullanıcısı:

1. Uygulamanızda veya [hydrawise.com](https://hydrawise.com)'da yeni bir hesap açın.
2. Kaydı yaptıktan sonra, hesabınıza gönderilen e-postadaki “Başlayalım” düğmesine tıklayın.
3. Hydrawise uygulamanızdaki veya web sitenizin ekranındaki “Başlayalım” düğmesine tekrar tıklayın.
4. X2 kontrol ünitenizi Hydrawise hesabınıza eklemek ve Wi-Fi'ye bağlanmak için tüm adımları izlemeye devam edin.

#### Mevcut Hydrawise hesabı kullanıcısı:

1. Hydrawise uygulamanızda veya hesabınızda oturum açın.
2. Hesabım menüsü altındaki “Kontrol Ünitelerim” bölümüne gidin.
3. Kontrol Ünitelerim listesinin altındaki + simgesine tıklayın.
4. X2 kontrol ünitenizi Hydrawise hesabınıza eklemek ve Wi-Fi'ye bağlanmak için tüm adımları izlemeye devam edin.

# Product Reset

---

## To factory reset the WAND Module

1. Press and hold the button on the WAND Module for 5 seconds. “Fdr” (factory default reset) will appear on the controller LCD.
2. The module LED will turn off.
3. Release the button when the solid amber ● LED appears and “done” displays on the controller LCD.
4. Return to the online setup wizard in your Hydrawise Controller settings account page to reconnect the WAND Module to Wi-Fi.

## Quick troubleshooting tips

- Be in range of Wi-Fi signal and verify with your smartphone.
- Verify correct Wi-Fi network name and password used.
- Verify Wi-Fi network is using 2.4 GHz and **not** 5 GHz.



<https://hunter.help/wifispecs>

## Solid LED color:

- The WAND Module is waiting for the user to add Wi-Fi credentials.
- Controller is online and connected to the Hydrawise server.
- Incorrect Wi-Fi password entered or Wi-Fi network lost.

## Flashing LED color:

- ☀ 2 blinks, WAND is in “SAP” (Wi-Fi Direct) mode.
- ☀ 3 blinks, WAND is in “Pbc” router-supported (WPS push-button) mode.

Refer to the online setup wizard for Wi-Fi instructions found in your Hydrawise controller settings account page.

## Firmware Update Codes

1. UPd8A - When online, the WAND LED will turn red ● and “UPd8A” will appear on the controller upgrading to the latest X2 Controller firmware.
2. UPd8b - When online, the WAND LED will turn amber ● and “UPd8b” will appear on the controller upgrading to the latest Hydrawise firmware.
3. UPd8C - When online, the WAND LED will stay green ● and “UPd8C” will appear on the controller upgrading to the latest Wi-Fi firmware.



## **DE** Zurücksetzen des Produkts Zurücksetzen des WAND-Moduls auf die Werkseinstellungen

1. Halten Sie die Taste WAND 5 Sekunden lang gedrückt. Auf der LCD-Anzeige des Steuergeräts erscheint daraufhin „Fdr“ (factory default reset, Zurücksetzen auf die Werkseinstellungen).
2. Die Modul-LED erlischt.
3. Lassen Sie die Taste los, wenn die LED dauerhaft gelb leuchtet  und auf der LCD-Anzeige des Steuergeräts „done“ (fertig) erscheint.
4. Rufen Sie den Online-Setup-Assistenten auf der Kontoseite in den Einstellungen Ihres Hydrawise-Steuergeräts erneut auf, um wieder eine WLAN-Verbindung für das WAND-Modul herzustellen.

### Tipps zur raschen Fehlerbehebung

- Achten Sie darauf, dass Sie sich in Reichweite des WLAN-Signals befinden, und bestätigen Sie dies über Ihr Smartphone.
- Überprüfen Sie, ob der Name und das Passwort des WLAN-Netzwerks stimmen.
- Vergewissern Sie sich, dass das WLAN-Netzwerk 2,4 GHz und nicht 5 GHz verwendet.

### LED leuchtet dauerhaft gelb:

-  Das WAND-Modul wartet auf die Eingabe von WLAN-Anmeldedaten durch den Benutzer.
-  Das Steuergerät ist online und mit dem Hydrawise-Server verbunden.

-  Es wurde ein falsches WLAN-Passwort eingegeben oder das WLAN-Netzwerk ist nicht mehr verfügbar.



### LED-Leuchte blinkt:

 2-faches Blinken: WAND befindet sich im „SAP“-Modus (Wi-Fi Direct).

 3-faches Blinken: WAND befindet sich im Router-gestützten „Pbc“-Modus (WPS).

Weitere Informationen zum WLAN finden Sie im Online-Setup-Assistenten auf der Kontoseite in den Einstellungen Ihres Hydrawise-Steuergeräts.

### Firmware-Update-Codes

1. UPd8A – Wenn das Gerät online ist, leuchtet die WAND-LED rot  und auf dem Steuergerät wird „UPd8A“ angezeigt. Es wird ein Upgrade auf die neueste X2-Steuergerät-Firmware vorgenommen.
2. UPd8b – Wenn das Gerät online ist, leuchtet die WAND-LED gelb  und auf dem Steuergerät wird „UPd8b“ angezeigt. Es wird ein Upgrade auf die neueste Hydrawise-Firmware vorgenommen.
3. UPd8C – Wenn das Gerät online ist, leuchtet die WAND-LED grün  und auf dem Steuergerät wird „UPd8C“ angezeigt. Es wird ein Upgrade auf die neueste WLAN-Firmware vorgenommen.



## Reinicio del producto

### Reinicio a los valores de fábrica de WAND

1. Mantenga presionado el botón WAND durante 5 segundos. En la pantalla LCD del programador aparecerá "Fdr" (restablecimiento de valores por defecto).
2. El LED del módulo se apagará.
3. Suelte el botón cuando la luz sea de color ámbar fijo Aparece la LED y en la pantalla LCD del programador el mensaje "done" (hecho).
4. Vuelva al asistente de configuración en línea de la página de configuración del programador Hydrawise para volver a conectar el WAND a la Wi-Fi.

### Consejos para resolución de problemas

- Manténgase dentro del alcance de la señal Wi-Fi y compruebe con su teléfono móvil.
- Compruebe que el nombre de la red Wi-Fi y la contraseña usada sean los correctos.
- Compruebe que la conexión esté en 2,4 GHz, no en 5 GHz.

### LED de color fijo:

- El WAND está a la espera de que el usuario añada las credenciales del Wi-Fi.
- El programador está en línea y conectado al servidor Hydrawise.
- Se ha introducido una contraseña de Wi-Fi incorrecta o se ha perdido la red Wi-Fi.

### LED de color parpadeante:

- 2 parpadeos, el WAND está en modo "SAP" (Wi-Fi Direct).
- 3 parpadeos, el WAND está en modo "Pbc" compatible con el router (botón WPS).

Consulte el asistente de configuración en línea para obtener las instrucciones sobre Wi-Fi que se encuentran en la página de la cuenta de configuración del programador Hydrawise.

### Códigos de actualización de firmware

1. UPd8A - Al estar en línea, el piloto LED del WAND se volverá rojo y aparecerá el código "UPd8A" en el programador que se está actualizando al firmware más reciente del programador X2.
2. UPd8b - Al estar en línea, el piloto LED del WAND se volverá ámbar y aparecerá el código "UPd8b" en el programador que se está actualizando al firmware más reciente de Hydrawise.
3. UPd8C - Al estar en línea, el piloto LED del WAND se volverá verde y aparecerá el código "UPd8C" en el programador que se está actualizando al firmware más reciente de wifi.

FR

## Réinitialisation du produit



### Réinitialisation d'usine du module WAND

1. Maintenez le bouton du module enfoncé pendant 5 secondes. Vous verrez alors apparaître « Fdr » (réinitialisation des paramètres d'usine) sur l'écran LCD du programmeur.
2. La diode du module s'éteint.
3. Relâchez le bouton lorsque la LED jaune fixe apparaît  et que « terminé » s'affiche sur l'écran LCD du programmeur.
4. Sur la page de votre compte, retournez à l'assistant de configuration en ligne dans les paramètres du programmeur Hydrawise afin de reconnecter le module WAND au Wi-Fi.



### Conseils de dépannage rapide

- Rapprochez-vous du signal Wi-Fi et vérifiez avec votre smartphone.
- Vérifiez que le nom du réseau Wi-Fi et le mot de passe utilisés sont corrects.
- Vérifiez que le réseau Wi-Fi est en 2,4 GHz et non 5 GHz.

### Couleur des LED fixes :



-  Le module WAND attend que l'utilisateur ajoute ses identifiants Wi-Fi.
-  Le programmeur est en ligne et connecté au serveur Hydrawise.
-  Mot de passe Wi-Fi incorrect ou réseau Wi-Fi perdu.

### Couleur des LED clignotantes :

-  2 clignotements : le module WAND est en mode « SAP » (direct Wi-Fi).
-  3 clignotements : le module WAND est en mode « PBC » compatible routeur (bouton WPS).

Reportez-vous à l'assistant de configuration en ligne, accessible sur la page des paramètres de votre programmeur Hydrawise, pour obtenir des instructions sur le Wi-Fi.

### Codes de mise à jour du micrologiciel

1. UPd8A – Une fois en ligne, la LED du module WAND devient rouge  et « UPd8A » s'affiche sur le contrôleur pendant la mise à niveau vers le dernier micrologiciel du contrôleur X2.
2. UPd8b – Une fois en ligne, la LED du module WAND devient orange  et « UPd8b » s'affiche sur le contrôleur pendant la mise à niveau vers le dernier micrologiciel Hydrawise.
3. UPd8C – Une fois en ligne, la LED du module WAND devient verte  et « UPd8C » s'affiche sur le contrôleur pendant la mise à niveau vers le dernier micrologiciel Wi-Fi.



## Reset del prodotto



### Ripristino alle impostazioni di fabbrica di WAND

1. Tenere premuto il pulsante WAND per 5 secondi. Sul display LCD del programmatore, comparirà la sigla “Fdr” (ripristino alle impostazioni di fabbrica).
2. Il LED del modulo verrà disattivato.
3. Rilasciare il pulsante quando compare il LED fisso  di colore arancio e sul programmatore LCD compare la scritta “fatto”.
4. Per riconnettere WAND al Wi-Fi, tornare alla procedura guidata di configurazione online nelle impostazioni del programmatore Hydrawise nella pagina dell'account.



### Consigli rapidi per la risoluzione problemi

- Accertarsi di essere nel raggio di portata del segnale Wi-Fi, verificando con il proprio smartphone.
- Verificare il nome di rete e la password del Wi-Fi utilizzati.
- Verificare il Wi-Fi utilizzi la connessione di rete a 2,4 GHz e non a 5 GHz.

### LED colorato fisso:



-  WAND è in attesa che l'utente aggiunga le credenziali del Wi-Fi.
-  Il programmatore è online e collegato al server Hydrawise.
-  La password Wi-Fi inserita è errata o la rete Wi-Fi è stata persa.

### LED colorato lampeggiante:

-  Il LED lampeggia 2 volte: WAND è in modalità “SAP” (Wi-Fi Direct).
-  Il LED lampeggia 3 volte: WAND è in modalità “Pbc” supportata dal router (pulsante WPS).

Consultare la procedura guidata di configurazione online per le istruzioni sul Wi-Fi nelle impostazioni del programmatore Hydrawise dalla pagina dell'account.

### Codici di aggiornamento del firmware

1. UPd8A - Quando sarà online, il LED WAND diventerà rosso  e sul programmatore nel quale è in corso l'upgrade all'ultima versione del firmware del programmatore X2 apparirà “UPd8A”.
2. UPd8b - Quando sarà online, il LED WAND diventerà color ambra  e sul programmatore nel quale è in corso l'upgrade all'ultima versione del firmware Hydrawise apparirà “UPd8b”.
3. UPd8C - Quando sarà online, il LED WAND rimarrà verde  e sul programmatore nel quale è in corso l'upgrade all'ultima versione del firmware Wi-Fi apparirà “UPd8C”.



## Redefinição de produto



### Restauração do WAND para o padrão de fábrica

1. Aperte e segure o botão do WAND por 5 segundos. “Fdr” (redefinição para o padrão de fábrica) aparecerá no LCD do controlador.
2. O LED do módulo se apagará.
3. Solte o botão quando o LED âmbar sólido  aparecer, exibindo “pronto” no LCD do controlador.
4. Retorne ao assistente de configuração online na página da conta de configurações do controlador Hydrawise para reconectar o WAND ao Wi-Fi.

#### Dicas para soluções rápidas

- Esteja dentro do alcance no sinal de Wi-Fi e verifique com o smartphone.
- Verifique se o nome da rede Wi-Fi e a senha estão corretos.
- Verifique se a rede Wi-Fi está usando 2,4 GHz e não 5 GHz.

#### Cor de LED sólida:

-  O WAND está aguardando que o usuário adicione as credenciais do Wi-Fi.
-  O controlador está online e conectado ao servidor do Hydrawise.
-  A senha inserida para o Wi-Fi está incorreta ou a rede Wi-Fi foi perdida.



#### Cor do LED piscando:

 Com duas piscadas, o WAND está no modo “SAP” (Wi-Fi Direct).

 Com três piscadas, o WAND está no modo compatível com o roteador “Pbc” (botão WPS).

Consulte o assistente de configuração online para ler as instruções sobre o Wi-Fi, na página da conta de configurações do controlador Hydrawise.

#### Códigos de atualização de firmware

1. UPd8A — Quando estiver online, o LED da WAND ficará vermelho  e aparecerá “UPd8A” no controlador que estiver atualizando para o firmware mais recente do controlador X2.
2. UPd8b — Quando estiver online, o LED da WAND ficará âmbar  e aparecerá “UPd8b” no controlador que estiver atualizando para o firmware mais recente do Hydrawise.
3. UPd8C — Quando estiver online, o LED da WAND ficará verde  e aparecerá “UPd8C” no controlador que estiver atualizando para o firmware mais recente do Wi-Fi.



## Ürün Sıfırlama

### WAND'ı Fabrika Ayarlarına Sıfırla

1. WAND düğmesini 5 saniye boyunca basılı tutun. Kontrol ünitesinin LCD ekranında "Fdr" (fabrika ayarlarına sıfırla) yazısı görünecektir.
2. Modül LED ışığı kapanacaktır.
3. Kalıcı amber renk LED görüldüğünde ● ve kontrol ünitesinin LCD ekranında "bitti" yazdığı anda düğmeyi bırakın.
4. WAND'ı Wi-Fi'ye yeniden bağlamak için Hydrowise kontrol ünitesi ayarları hesap sayfanızdaki çevrimiçi kurulum sihirbazına geri dönün.

### Hızlı Sorun Giderme İpuçları

- Wi-Fi sinyali aralığında olun ve akıllı telefonunuzla doğrulayın.
- Doğru Wi-Fi ağ adını ve parolasını kullandığınızı doğrulayın.
- Wi-Fi ağının 2.4 GHz ve 5 GHz kullandığını doğrulayın.

### Düz LED Rengi:

- WAND, kullanıcının Wi-Fi giriş bilgilerini eklemesini bekliyor.
- Kontrol Ünitesi Çevrimiçi ve Hydrowise sunucusuna bağlı.
- Yanlış Wi-Fi şifresi girildi veya Wi-Fi ağı kayboldu.

### Yanıp sönen LED Rengi:

- 2 yanıp sönmeye, WAND "SAP" (Wi-Fi Direk) modunda.
- 3 yanıp sönmeye, WAND, "Pbc" yönlendirici-router destekli (WPS düğmesi) modda.

Hydrowise kontrol ünitesi ayarları hesap sayfanızda bulunan Wi-Fi yönergeleri için çevrimiçi kurulum sihirbazına bakın.

### Firmware Güncelleme Kodları

1. UPd8A - Çevrimiçi iken, WAND LED kırmızı ● yanacak ve en son X2 Kontrol ünitesinin ürün yazılımına yükseltme yapan "UPd8A" kontrol ünitenizde görünecektir.
2. UPd8b - Çevrimiçi iken, WAND LED kehribar ● yanacak ve en son Hydrowise yazılımına yükseltme yapan "UPd8b" kontrol ünitenizde görünecektir.
3. UPd8C - Çevrimiçi iken, WAND LED yeşil ● renkte kalacak ve en son Wi-Fi üretici yazılımına yükseltme yapan "UPd8C" kontrol ünitenizde görünecektir.



### FCC Compliance Notice

This equipment has been tested and found to comply with the limits for a Class B digital device pursuant to Part 15 of the FCC Rules. These limits are designed to provide reasonable protection against harmful interference in a residential installation. This equipment generates, uses, and can radiate radio frequency energy and, if not installed and used in accordance with the instructions, may cause harmful interference to radio communications. However, there is no guarantee that interference will not occur in a particular installation. If this equipment does cause harmful interference to radio or television reception, which can be determined by turning the equipment off and on, you are encouraged to try to correct the interference by taking one or more of the following measures:

- Reorient or relocate the receiving antenna.
- Increase the separation between the equipment and receiver.
- Connect the equipment into an outlet on a circuit different from that of which the receiver is connected.
- Consult the dealer or an experienced radio/TV technician for help.

This device complies with part 15 of FCC rules. Operation is subject to the following two conditions:

1. This device may not cause harmful interference.
2. This device must accept any interference received, including interference that may cause undesired operation.

Changes or modifications not expressly approved by Hunter Industries could void the user's authority to operate this device. If necessary, consult a representative of Hunter Industries Inc. or an experienced radio/television technician for additional suggestions.

The following statement is applicable when irrigation controller is used with accessory Wi-Fi device: This equipment complies with FCC radiation exposure limits set forth for an uncontrolled environment. In order to avoid the possibility of exceeding the FCC radio frequency exposure limits, human proximity to the antenna shall not be less than 7.9" (20 cm) during normal operation.

This equipment complies with the IC RSS-102 radiation limits set forth for an uncontrolled environment. This equipment should be installed and operated with a minimum distance of 7.9" (20 cm) from all persons.

## Compliance

---

### Innovation, Science and Economic Development Canada (ISED) Compliance Notice

This device contains licence-exempt transmitter(s)/receiver(s) that comply with Innovation, Science and Economic Development Canada's licence-exempt RSS(s).

Operation is subject to the following two conditions:

1. This device may not cause interference, and
2. This device must accept any interference, including interference that may cause undesired operation of the device.

Le présent appareil est conforme aux CNR d'Innovation, Sciences et Développement économique Canada applicables aux appareils radio exempts de licence.

L'exploitation est autorisée aux deux conditions suivantes :

1. L'appareil ne doit pas produire de brouillage, et
2. L'utilisateur de l'appareil doit accepter tout brouillage radioélectrique subi, même si le brouillage est susceptible d'en compromettre le fonctionnement.

### Certificate of Conformity to European Directives

Hunter Industries declares that the irrigation controller complies with the standards of the European Directives of "electromagnetic compatibility" (2014/30/EU), "low voltage" (2014/35/EU), and "radio equipment" (2014/53/EU).



#### Bluetooth:

- Frequency band of operation: 2400 MHz to 2480 MHz
- Bluetooth: Maximum transit power less than 20 dBm EIRP
- Bluetooth Low Energy: Maximum power spectral density less than 10 dBm/MHz EIRP

<b>Model Number</b>	WAND
---------------------	------

<b>Manufacturer</b>	Hunter Industries, 1940 Diamond Street, San Marcos, CA 92078
---------------------	--

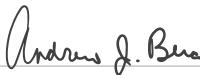

Andrew Bera, Senior Regulatory Compliance Engineer

<b>Place</b>	San Marcos, CA
<b>Date</b>	November 11, 2020



---

Helping our customers succeed is what drives us. While our passion for innovation and engineering is built into everything we do, it is our commitment to exceptional support that we hope will keep you in the Hunter family of customers for years to come.



**Gregory R. Hunter, CEO of Hunter Industries**



**Gene Smith, President, Landscape Irrigation and Outdoor Lighting**

---

**HUNTER INDUSTRIES** | *Built on Innovation*<sup>®</sup>

1940 Diamond Street, San Marcos, CA 92078 USA

[hunterindustries.com](http://hunterindustries.com)

© 2021 Hunter Industries™. Hunter, the Hunter logo and all other trademarks are property of Hunter Industries, registered in the U.S. and other countries.